



武汉孚特锂能科技有限公司  
Wuhan Forte Battery Co., Ltd

Version: A1

Add: Wujiashan Taiwan Businessmen Investment  
Zone, Wuhan, Hubei, China

Date: 2023/08/14

Http://www.whforte.cn Email: forte@whforte.com



### Li-MnO<sub>2</sub> Battery Specification

### 锂二氧化锰电池规格书

**MODEL/型号: CR2**

Prepared By/Date 编制/日期	Checked By/Date 审核/日期	Approved By/Date 批准/日期
 2023.8.14	 23.8.14	

	Signature 确认	Date 日期
Customer Approval 客户批准	Company Name: 公司名称:	
	Company Stamp: 客户印章:	



武汉孚特锂能科技有限公司  
Wuhan Forte Battery Co., Ltd

Version: A1

Add: Wujiashan Taiwan Businessmen Investment  
Zone, Wuhan, Hubei, China

Date: 2023/08/14

Http://www.whforte.cn Email: forte@whforte.com



## 1 Scope (适用范围)

This specification is applied to the reference battery in this Specification that manufactured by Wuhan Forte Battery Co., Ltd

本说明书适用于武汉孚特锂能科技有限公司制造的电池。

## 2 Product Specification (产品技术规格)

Table 1 (表 1)

No.	Item 项目	Specification 规格
1	Voltage 标称电压	3.0 V
2	Capacity 容量 (Discharge to 2.0V @5mA/Upright) 正立 5mA 放电至 2.0V	Standard Cap 标称容量 850 mAh
3	Max Discharge current 最大放电电流	Continuity 连续 1000 mA
		Plus 脉冲 2000 mA
4	Termination Vol. 截止电压	2.0 V
5	CCV@56Ω 负载电压@56Ω	2.8 V
6	Weight 重量	Approx.约 13g
7	Work Temp 工作温度	-40 °C to 85 °C
8	Storage Temp 储存温度	10 °C to 25 °C
9	Storage Humidity 储存湿度	≤65%
10	Guarantee Period 保持期	10 年



武汉孚特锂能科技有限公司  
Wuhan Forte Battery Co., Ltd

Version: A1

Add: Wujiashan Taiwan Businessmen Investment  
Zone, Wuhan, Hubei, China

Date: 2023/08/14

Http://www.whforte.cn Email: forte@whforte.com

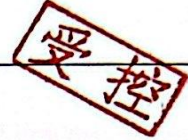

### 3 Performance And Test Conditions (电池性能及测试条件)

#### 3.1 Standard Test Conditions (标准测试条件)

Test should be conducted with new batteries within one week Unless otherwise specified, test and measurement shall be done under temperature of  $23 \pm 2^\circ\text{C}$  and relative humidity of 45~85%. If it is judged that the test results are not affected by such conditions, the tests may be conducted at temperature  $15 \sim 30^\circ\text{C}$  and humidity 25~85%RH.

测试必须使用出厂时间不超过一个星期的新电池。除非特别说明，否则测试会在温度  $23 \pm 2^\circ\text{C}$ ，相对湿度 45~85% 的条件下进行。如果经鉴定测试结果不受上述条件影响，测试也可以在温度  $15 \sim 30^\circ\text{C}$ ，相对湿度 25~85%RH 的条件下进行。

#### 3.2 Measuring Instrument or Apparatus (测量器具及设备)

##### 3.2.1 Dimension Measuring Instrument (尺寸测量器具)

The dimension measurement shall be implemented by instruments with equal or more precision scale of 0.01mm.

尺寸测量器具的精度等级应不小于 0.01 mm。

##### 3.2.2 Voltmeter (伏特计)

Standard class specified in the national standard or more sensitive class having inner impedance more than  $10\text{k}\Omega/V$

按照国家标准指定规格等级或采用灵敏度更高的，测量电压时内阻不应小于  $10\text{k}\Omega/V$ 。

##### 3.2.3 Ammeter (安培计)

Standard class specified in the national standard or more sensitive class. Total external resistance including ammeter and wire is less than  $0.01\Omega$ .

按照国家标准指定规格等级或采用灵敏度更高的，包括电流表及电线在内的总外阻应小于  $0.01\Omega$ 。

3.3. Standard Discharge (标准放电): Cells shall be discharged at a constant current of 5mA to 2.0 volts @  $23 \pm 2^\circ\text{C}$  (电池以 5mA 恒流放电至 2.0V @  $23 \pm 2^\circ\text{C}$ )

3.4 Appearance (外观): There shall be no such defect as flaw, crack, rust, leakage, which may adversely affect commercial value of battery. (电池外观应没有划伤、破裂、污渍、生锈、漏液等影响市场价值的缺陷存在)。

Item (项目)	Test Method and Condition (测试方法及条件)	Requirements (要求)
(1) Open-Circuit Voltage (开路电压)	Measure with DC Voltage meter 用直流电压表测量.	$\geq 3.0\text{V}$
(2) Minimal Rated Capacity (最小额定容量)	Discharge to 2.0V 5mA (5mA 放电至 2.0V)	Discharge Capacity (放电容量) $\geq 850\text{mAh}$
(3) Quickly Discharge Capacity (快速放电)	Discharge to 2.0V 200mA (200mA 放电至 2.0V)	Discharge Capacity (放电容量) $\geq 600\text{mAh}$



武汉孚特锂能科技有限公司  
Wuhan Forte Battery Co., Ltd

Version: A1

Add: Wujiashan Taiwan Businessmen Investment  
Zone, Wuhan, Hubei, China

Date: 2023/08/14

Http://www.whforte.cn Email: forte@whforte.com



3.6 Temperature Dependence of discharge capacity (放电温度特性)

Cells shall be discharged per 3.3 and discharged @5mA to 2.0 volts. Except to be discharged at temperatures per Table 3. Cells shall be stored for 3 hours at the test temperature prior to discharging and then shall be discharged at the test temperature. The capacity of a cell at each temperature shall be compared to the capacity achieved at 23 ± 2 °C and the percentage shall be calculated. Each cell shall meet or exceed the requirements of Table 3.

电池按 3.3.规定放电。按表 3 的温度中放电，电池必须先在该试验温度中放置 3 个小时。在每一个温度中的放电容量应不小于表 3 的要求。

Table 3 (表 3)

Discharge Temperature (放电温度)	-40°C	0°C	23±2°C	50°C	72°C
Discharge to 2.0V 5mA (5mA 放电至 2.0V)	45%	60%	100%	95%	90%

4. Mechanical characteristics and Safety Test (安全测试及机械特性)

Table 4 (表 4)

(Mechanical characteristics)

No. (序号)	Items (项目)	Test Method and Condition (测试方法及条件)	Criteria (标准)
1	Vibration Test 振动测试	Fixed the cell to vibration table and subjected to vibration cycling that the frequency is to be varied at the rate of 1Hz per minute between 10Hz an 55Hz, the excursion of the vibration is 1.6mm. The cell shall be vibrated for 30 minutes per axis of XYZ axes. 将电芯固定在振动台上，沿 X、Y、Z 三个方向各振动 30 分钟，振幅 1.6mm，振动频率为 10Hz~55Hz，每分钟变化 1Hz。	No leakage 无泄漏 no weight loss 无失重 no short circuit 无短路 No fire 不起火 No explosion, 无爆炸
2	Altitude Simulation Test 高空模拟	The batteries should be stored at the pressure of 11.6 KPa or less for at least six hours at ambient temperature 23 ± 2 °C.	No leakage 无泄漏 no weight loss 无失重 no short circuit 无短路 No fire 不起火 No explosion, 无爆炸



武汉孚特锂能科技有限公司  
Wuhan Forte Battery Co., Ltd

Version: A1

Add: Wujiashan Taiwan Businessmen Investment  
Zone, Wuhan, Hubei, China  
Http://www.whforte.cn Email: forte@whforte.com

Date: 2023/08/14



Table 4 (表 4 续)

(Mechanical characteristics)

No. (序号)	Items (项目)	Test Method and Condition (测试方法及条件)	Criteria (标准)
3	Short test 短路测试(25+5° C)	The fully charged battery is to be short-circuited by connecting the positive and negative terminals of the battery with resistance load not exceed 100mQ. Tests are to be conducted at room temperature 25+5C 在室温 25+5C 把充满电的电池的正负极用不超过 100mQ 的负载连接起来, 连接起来使电池外部短路	No Fire.No explosion Surface temperature does not exceed 150C 无起火, 无爆炸 表面温度不超过 150C
4	Impact (冲击试验)	A 56mm diameter bar is inlaid into the bottom of a 10kg weight. And the weight is to be dropped from a height of 1m onto a sample battery and then the bar will be across the center of the sample. (用一条直径为 56mm 的圆棒放置在电池中央, 将一 10Kg 的重锤从 1m 的高度垂直落下在电池的中心位置)	No leakage 无泄漏 no short circuit 无短路 No fire 不起火 No explosion, 无爆炸
5	Free fall (跌落测试)	Fresh batteries; Height: 1.2m, 6 times; Each direction two times; Concrete floor(每个样品电池从 1.2 米高处自由落体测试 6 次。)	No leakage 无泄漏 no short circuit 无短路 No fire 不起火 No explosion, 无爆炸
6	Over discharge (过放电)	Complete discharged battery, connected in series with two fresh cells and resistor load 3ohm for 36h or cell temperature returned to ambient. (一个完全放电的电芯被强制性串联同型号的新电芯, 串联的新电芯数目=串联应用的最大数目-1。当完全放电的电芯与特定数目的新电芯串接好后, 连接 1 个 3 欧姆负载 36 小时。)	No explosion 无爆炸 No fire 无起火



武汉孚特锂能科技有限公司  
Wuhan Forte Battery Co., Ltd

Version: A1

Add: Wujiashan Taiwan Businessmen Investment  
Zone, Wuhan, Hubei, China

Date: 2023/08/14

Http://www.whforte.cn Email: forte@whforte.com



#### 5. Environment requirement(环保)

The product does not contain controlled substances of level 1.  
该产品不含一级环境管理物质。

#### 6. Producing standard and certification(生产标准)

The batteries are produced according with the IEC standard.  
生产的产品满足国际IEC标准。

#### 7. Transportation(运输):

- The Batteries should be stored away from solarization, fire, rain, water, and never put together with corrosive during transportation.
- Vibration and shock during transportation and load-and-unload should be restrict to a minimum level.
- The height should not exceed 1.5m for cardboard packages.
- The batteries if transported by sea should be stored away from ship engines during prolonged transit, and not left for long periods in unventilated environment during summer.
- 电池在运输过程中,应避免日晒\火烤、水浸及与腐蚀性物质放在一起。
- 运输和装卸中的冲击、震动应限制在最小程度。
- 对于纸质的包装箱堆放高度不得超过1.5米。
- 电池长途运输时,如是船运,应放在远离发动机的地方;夏季不应该长期滞留在不通风的环境内。

#### 8. Information for safety(注意事项)

##### ! Danger(危险)

- Do not overheat batteries or dispose of batteries in fire.
- Do not put batteries together with metalwork such as necklace, coins, etc. in one bag, or store them together.
- Do not short-circuit batteries.
- Do not inset batteries in reverse. Observe the + and - markings on battery and equipment.
- Do not disassemble batteries.
- Do not weld or solder directly to batteries.
- Do not use deformed batteries or batteries with serious scar.
- Do not throw the battery onto the ground or wall.
- Read the guide carefully before using batteries. Unsuitable operation will make batteries overheat, fire, explode, destroy or reduce battery's capacity.
- 不要把电池加热或投进火中。
- 不要把电池同项链、发夹、硬币或螺丝等金属品一起放在兜中或包中,也不要将电池同上述物品一起储存。
- 不要使用金属导体短路电池的正负极。



武汉孚特锂能科技有限公司  
Wuhan Forte Battery Co., Ltd

Version: A1

Add: Wujiashan Taiwan Businessmen Investment  
Zone, Wuhan, Hubei, China

Date: 2023/08/14

Http://www.whforte.cn Email: forte@whforte.com



- 在装入设备时注意电池的正负极不要反装。
- 不要对电池进行分解。
- 不要直接对电池进行焊接。
- 不要使用带有严重伤痕或变形的电池。
- 不要将电池往地面（或墙面）上摔。
- 在使用之前请仔细阅读操作说明书，不适当的操作可能引起电池发热、着火、爆炸、毁坏或电池容量的衰减。

**! Warning (警告)**

- Do not place the battery in heater, washer or high-pressure container.
- Do not use the battery together with different kind of or different type of battery.
- Stop using when the battery become heat, emit smell or appear other abnormality during use, or storing.
- 不要把电池放在热器，洗衣机或高压容器中。
- 不要把电池同干电池或其他原电池一起使用，也不要不同包装、不同型号或不同品牌的电池一起使用。
- 在使用或储存期间如发现电池有发热、散发气味、变色、变形或其他异常之处停止使用。
- Do not recharge the battery.
- Do not force-discharge the battery.
- Keep away from the battery when the battery is leakage or emit abnormal smell.
- Wash yourself quickly when the electrolyte infiltrate to your skin or clothes.
- Wash your eyes by clean water quickly and go to hospital for further check if the electrolyte infiltrate to your eyes.
- If two or more batteries are to be connected in a series and / or placed in a parallel arrangement , protective circuit must be connected with batteries, so that to avoid force-discharging or recharging .
- 不要对电池充电。
- 不要使电池强制放电。
- 当发现电池漏液或散发出难闻的气味时立即远离。
- 如果电解液渗透到你的皮肤或衣服上，立刻用清水清洗。
- 如果电解液渗出并进入你的眼睛里，不要揉擦你的眼睛，立刻用干净的水清洗并去医院检查。
- 对电池进行串联和（或）并联时必须对每个电池采取电路保护措施，以保证每个电池不被充电、不被强制放电。

**! Caution(注意)**

- Read the guide carefully and pay attention to the guide when using the battery.

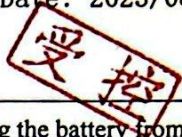
	武汉孚特锂电科技有限公司 Wuhan Forte Battery Co., Ltd	Version: A1
	Add: Wujiashan Taiwan Businessmen Investment Zone, Wuhan, Hubei, China Http://www.whforte.cn Email: forte@whforte.com	Date: 2023/08/14 
<ul style="list-style-type: none"> <li>— Read the instrument guide carefully before installing the battery or uninstalling the battery from the instrument.</li> <li>— Take out of the battery from the instrument if the on-load voltage of battery is less than 2V.</li> <li>— Take out the battery and keep it under the condition of normal temperature and low humidity when the battery is not used in a long time.</li> <li>— Clean the battery with dry cloth before use if the connection of the battery is dirty.</li> <li>— 在使用电池时，应仔细阅读并注意使用中的注意事项。</li> <li>— 在将电池装入设备或从设备中取出之前详细阅读。</li> <li>— 电池负载电压低于 2.0V 后，电池要立即从设备中取出。</li> <li>— 当长期不用时，要将电池从设备中取出并放在常温低湿的环境中保存。</li> <li>— 如果电池的接线端变脏，在使用之前用干布擦净。</li> </ul> <p><b>9. Storage (储存)</b></p> <ul style="list-style-type: none"> <li>— The batteries should be stored at 10°C~25°C (never exceed 30°C), 45%~75%RH.</li> <li>— The batteries should not be stored next to heat sources nor in direct sunlight. The storage area should be clean, cool, dry, ventilated and weatherproof.</li> <li>— The height to which batteries may be stacked is clearly dependent on the strength of the packaging. As a general rule, this height should not exceed 1.5m for cardboard packages nor 3m for wooden cases.</li> <li>— Store and display batteries in their original package. The batteries may be short-circuited or damaged if been unpacked and stacked mussily.</li> <li>— 电池应保存在 10°C~25°C (不可超过 30°C)、湿度 45%~75%的环境中。</li> <li>— 电池储存时要远离热源，也不能置于阳光直射的地方，保证清洁、凉爽、干燥、通风，并不受气候影响。</li> <li>— 电池的堆放高度取决于包装强度，一般规定，纸质包装箱堆放高度不得超过 1.5 米，木箱不超过 3 米。</li> <li>— 电池以原包装存放和陈列电池，去掉包装后电池乱堆放，易引起电池短路和损坏。</li> </ul> <p><b>10. Declaration (声明) :</b></p> <ul style="list-style-type: none"> <li>— Please contact with Wuhan Forte Battery Co Ltd . If you have any question with this specification.</li> <li>— Wuhan Forte Battery Co Ltd keep the right to change the specification.</li> <li>— Any other items which are not covered in this specification shall be agreed by both parties.</li> <li>— 若对此技术规格书有疑问或意见不一致处，请与武汉孚特锂电科技有限公司联系。</li> <li>— 武汉孚特锂电科技有限公司保留对规格书更改的权利。</li> <li>— 任何本产品规格书未包含的其它条款，应由双方协议确定。</li> </ul>		



武汉孚特锂能科技有限公司  
Wuhan Forte Battery Co., Ltd

Add: Wujiashan Taiwan Businessmen Investment  
Zone, Wuhan, Hubei, China  
Http://www.whforte.cn Email: forte@whforte.com

Version: A1

Date: 2023/08/14

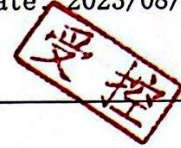

**Discharge characteristic 放电特性 (25°C)**

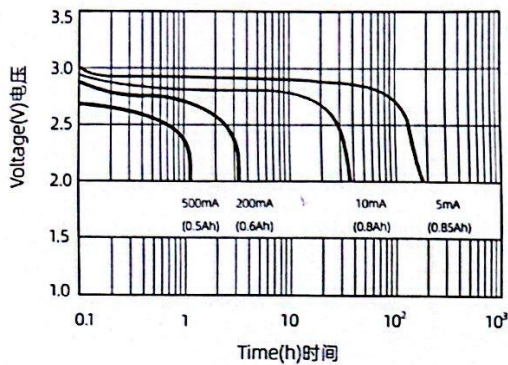

**Temperature Characteristics 温度特性**

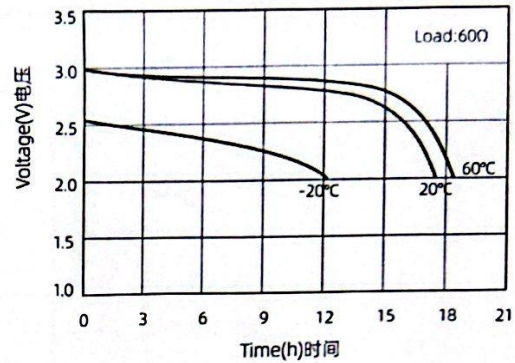

**Pulse Discharge 脉冲放电**

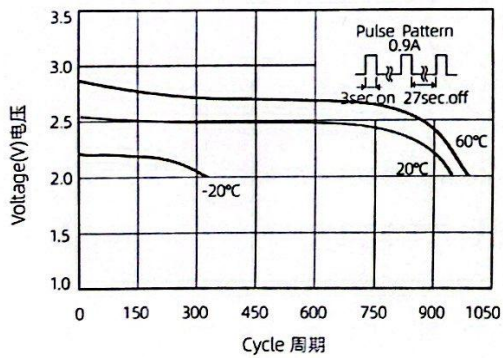

**Storage characteristics 存储特性**

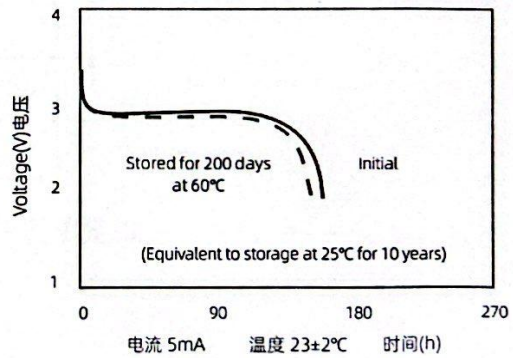



11. Battery Dimension 电池尺寸图

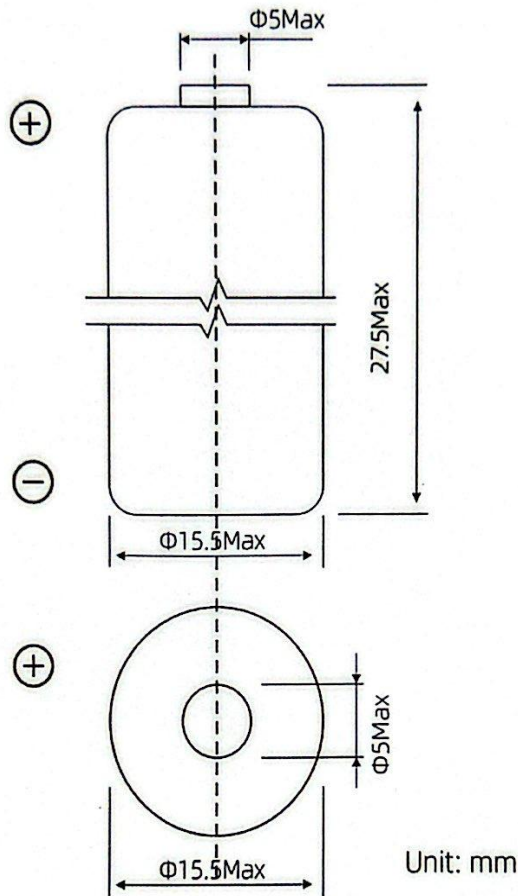

极端样式可按照客户要求定做